

Strada SPIRU HARET
Sectione transversala 1-1
Scara 1:100

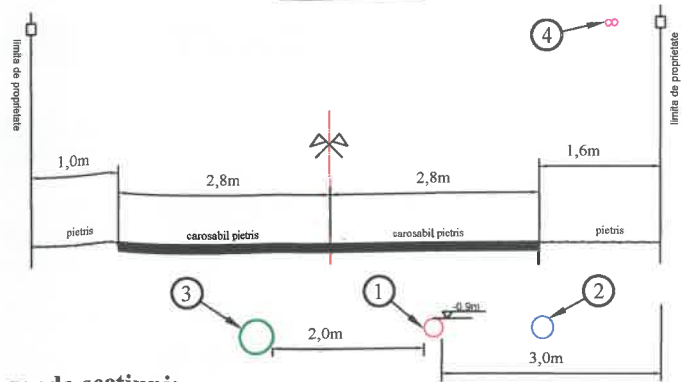

- Legenda sectiuni:**
1. Conducta distributie gaze naturale MP, proiectata din PE100 SDR11 DN 63mm
 2. Retea distributie apa existenta
 3. Retea canalizare menajera existenta
 4. Retea LEA existenta

Strada SPIRU HARET DS
Sectione transversala 2-2
Scara 1:100

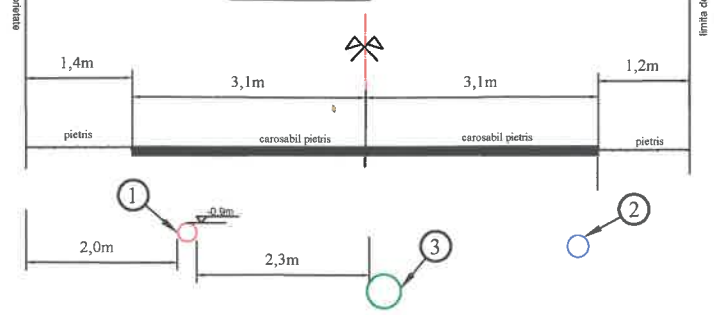

- Legenda sectiuni:**
1. Conducta distributie gaze naturale MP, proiectata din PE100 SDR11 DN 63mm
 2. Retea distributie apa existenta
 3. Retea canalizare menajera existenta
 4. Retea LEA existenta

NOTA :

Categoria de importanta a lucrarii este "C" constructii de importanta normala. Reprezentarea retelor edilitare are caracter informativ, confirmand numai existenta acestora in zona nu si pozitia exacta sau adancimea la care sunt ingropate. Inainte de inceperea lucrarilor se vor efectua sondaje pentru depistarea retelor subterane existente. Pentru situatii neprevazute aparute in timpul executiei, se vor respecta prevederile normativului NTPEE - 2018 sau va fi solicitata prezenta proiectantului in santier. **Punctul de legatura este informativ, urmand a se stabili cu exactitate prin sondaj la inceperea lucrarilor.** Probele de presiune cu aer vor fi executate corespunzator treptei de reducere a presiunii, astfel:
 - proba de rezistenta : p= 9 bar, t=1h
 - proba de etanseitate : p= 6 bar, t=24h
 Se vor respecta normele conform NTPEE-2018.

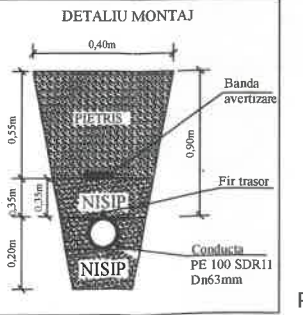
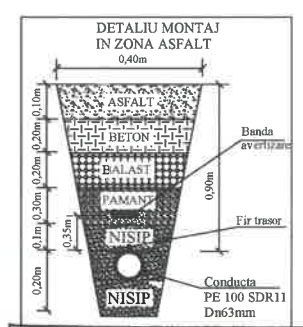
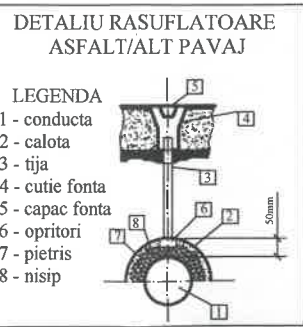

JUDEȚUL PRAHOVA PRIMĂRIA ORĂȘULUI MIZIL

VIZAT SPRE NESHIMBĂRE

Anexă la autorizația de construire desființare

Nr. 11 din 08.06.2023

Arhitect șef,

ING. TANASIA ANRE
 Nr. V150900143
 VERIFICATOR PROIECT

PROIECTARE:

EXECUTIE:

ing. MARCU GABRIEL
 INSTALATOR AUTORIZAT GAZE NATURALE
 TIP: PGD NR. 209200449/ OCT 2025

SOCIETATEA COMERCIALA TANMAR PRO GRUP SRL
 GIURGIU - ROMANIA

ING. TANASE ALEXANDRU-GEORGE
 INSTALATOR AUTORIZAT GAZE NATURALE
 TIP: EGD NR. 5111EU18506 NOV 2026

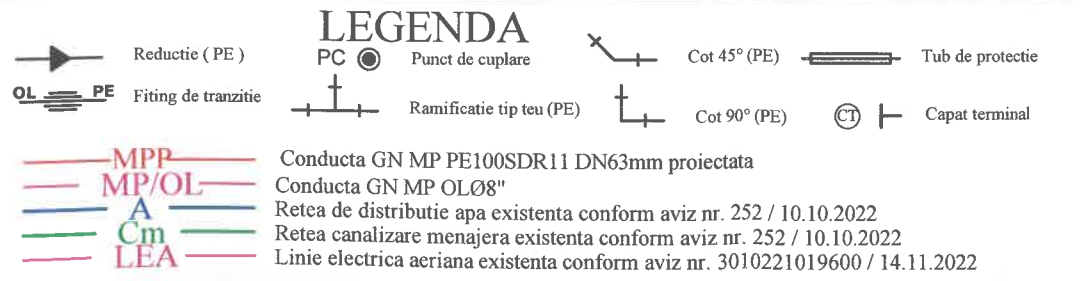

S.C TANMAR PRO GRUP S.R.L. RO38838285, J52/85/09.02.2018 Jud. Giurgiu, Com. Ulmi, Str. Principala, Nr. 253 Tel. 0727.293.902, e-mail : office.tanmar@gmail.com		Nr. proiect: 171-MI / 07.2022	
Beneficiar : SC PREMIER ENERGY SRL pentru TEODORESCU LOREDANA		Denumire proiect : Extindere conducta GN MP PE100SDR11 DN63mm, L=105m si racord aferent PE100SDR11 DN32mm, L=3,0m	
SPECIFICATIE	NUME	SEMNTURA	Faza: DTAC
PROIECTAT	Inst. aut. gr. PGD Ing. Marcu Gabriel	"	Amplasament : STR. SPIRU HARET SI STR. SPIRU HARET (DRUM ACCES), ORAS MIZIL, JUD. PRAHOVA
DESENAT	Inst. aut. gr. PGD Ing. Marcu Gabriel	"	
VERIFICAT	Inst. aut. gr. PGD Ing. Tanase Bogdan	"	Titlu plansa: PLAN DE SITUATIE
Scara: 1:500		Data: 2023	Plansa: P2/4

DETALIU PUNCT DE CUPLARE

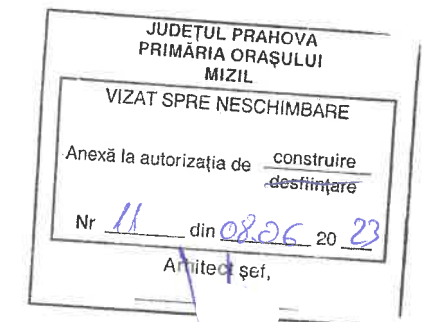
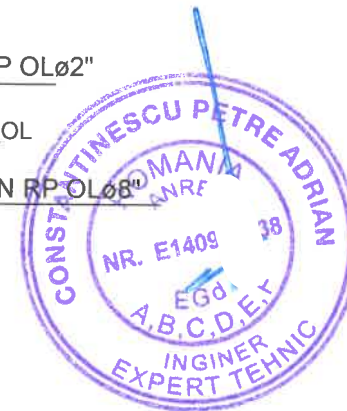
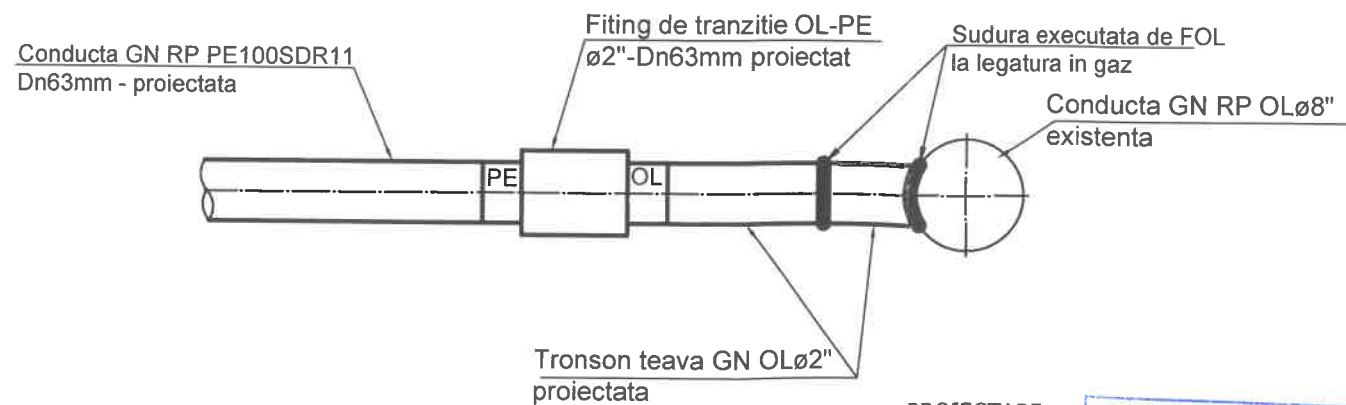
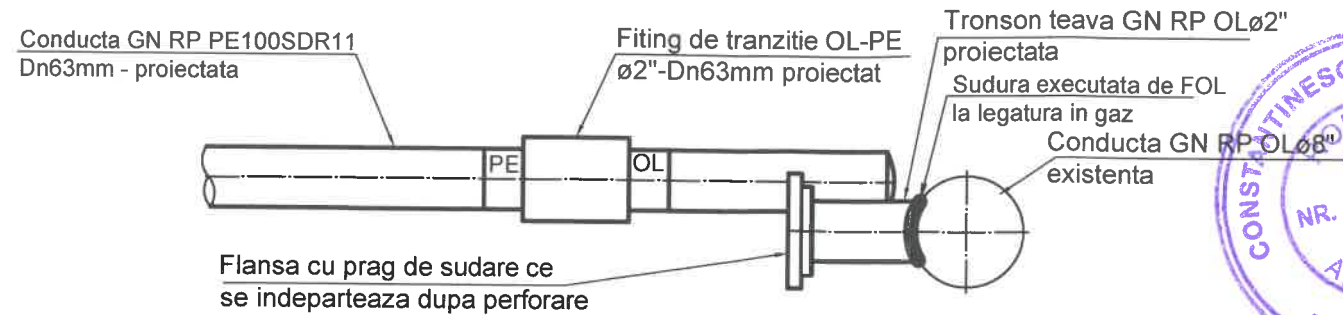
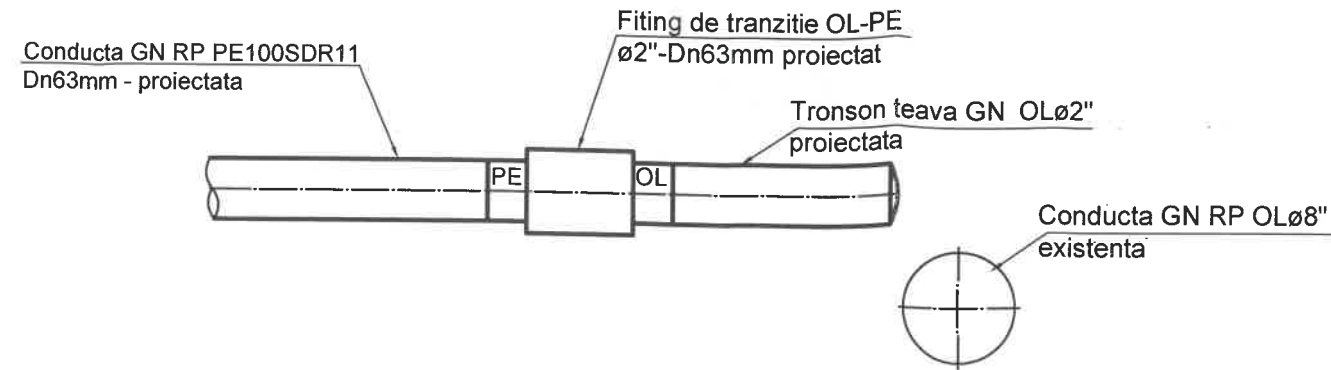

PROIECTARE:

ing. MARCU GABRIEL
INSTALĂTOR AUTORIZAT GAZE NATURALE
TIP: PGD NR. 209200449/ OCT 2025



S.C TANMAR PRO GRUP S.R.L. RO38838285, J52/85/09.02.2018 Jud. Giurgiu, Com. Ulmi, Str. Principala, Nr. 253 Tel. 0727.293.902, e-mail : office.tanmar@gmail.com			Nr. proiect: 171-MI / 07.2022	
			Beneficiar : SC PREMIER ENERGY SRL pentru TEODORESCU LOREDANA	
SPECIFICATIE	NUME	SEMNATURA	Scara:	Denumire proiect : Extindere conducta GN MP PE100SDR11 DN63mm, L=105m si racord aferent PE100SDR11 DN32mm, L=3,0m
PROIECTAT	Inst. aut. gr. PGD Ing. Marcu Gabriel		VAR.	Faza: DTAC
DESENAT	Inst. aut. gr. PGD Ing. Marcu Gabriel			Amplasament : STR. SPIRU HARET SI STR. SPIRU HARET (DRUM ACCES), ORAS MIZIL, JUD. PRAHOVA
VERIFICAT	Inst. aut. gr. PGD Ing. Tanase Bogdan		Data:2023	Planșa: P3/4
			Titlu planșa: DETALIU PUNCT DE CUPLARE	

SCHEMA IZOMETRICA

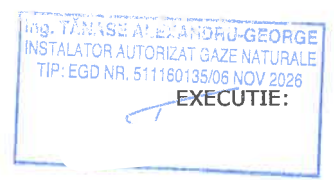
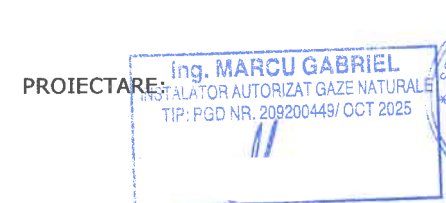
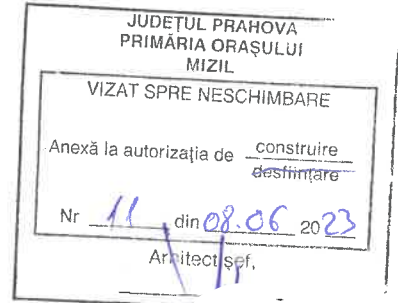
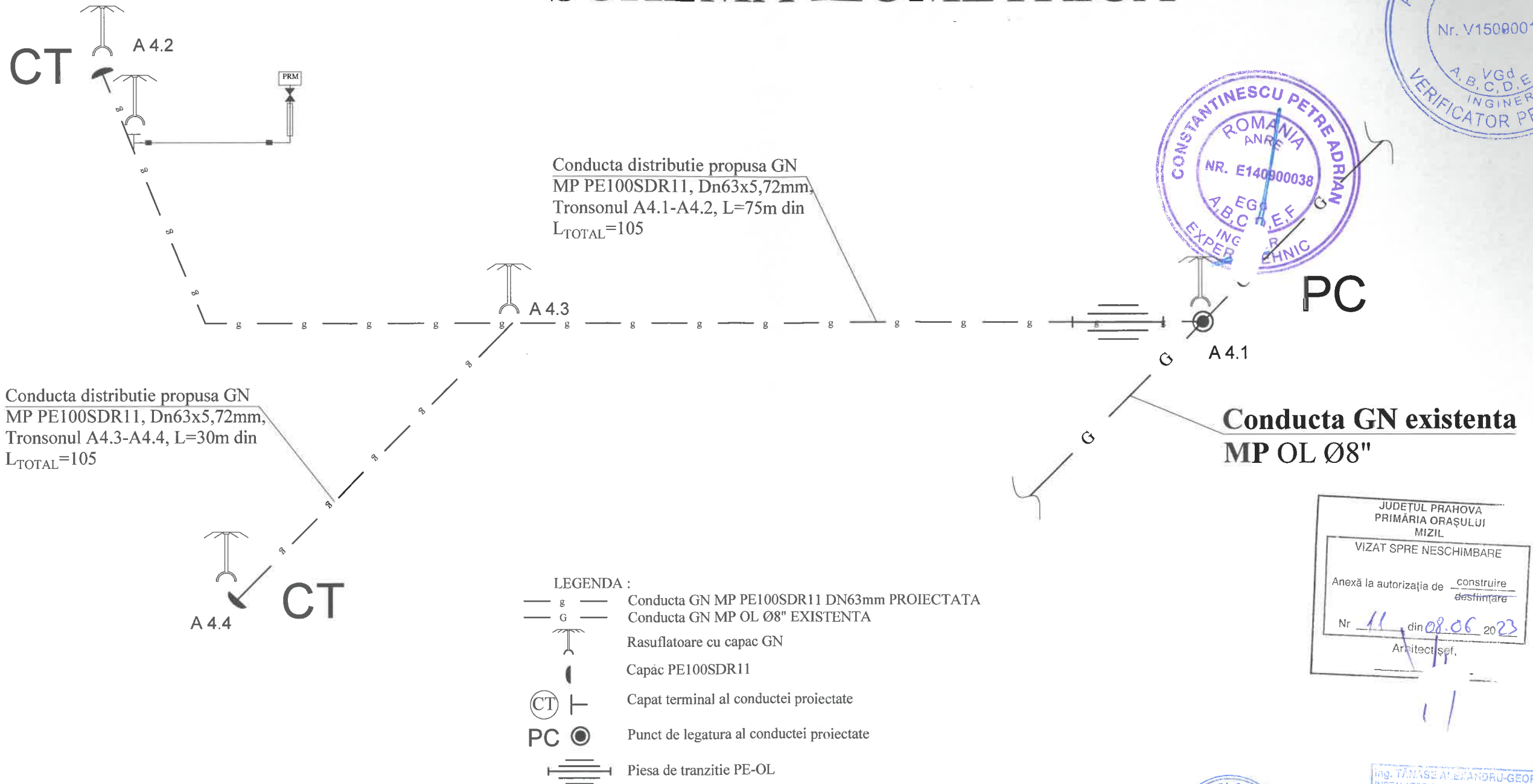

S.C TANMAR PRO GRUP S.R.L. RO38838285, J52/85/09.02.2018 Jud. Giurgiu, Com. Ulmi, Str. Principala, Nr. 253 Tel. 0727.293.902, e-mail : office.tanmar@gmail.com			Nr. proiect: 171-MI / 07.2022 Beneficiar : SC PREMIER ENERGY SRL pentru TEODORESCU LOREDANA		
SPECIFICATIE	NUME	SEMNATURA	Scara: VAR. Data:2023	Denumire proiect : Extindere conducta GN MP PE100SDR11 DN63mm, L=105m si record aferent PE100SDR11 DN32mm, L=3,0m Amplasament : STR. SPIRU HARET SI STR. SPIRU HARET (DRUM ACCES), ORAS MIZIL, JUD. PRAHOVA	Faza: DTAC
PROIECTAT	Inst. aut. gr. PGD Ing. Marcu Gabriel			Titlu plansa: SCHEMA IZOMETRICA	Plansa: P4/4
DESEMAT	Inst. aut. gr. PGD Ing. Marcu Gabriel				
VERIFICAT	Inst. aut. gr. PGD Ing. Tanase Bogdan				